

PROFILE SHAPES

I-beam

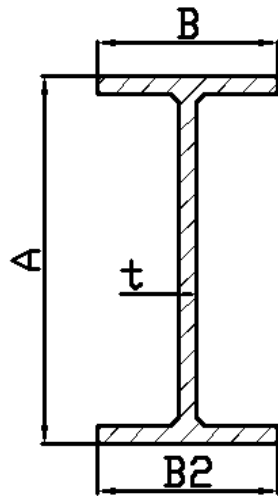
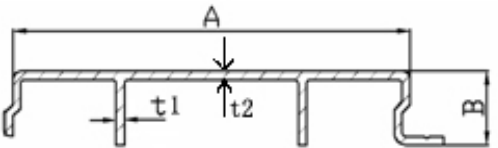
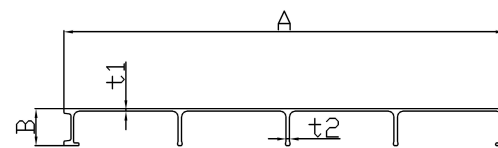
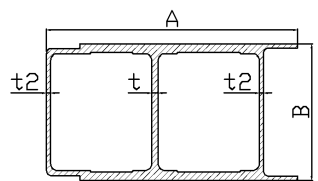

NO.	A	B/B2	t	Item
1	200	200	10	I-0441
2	200	100/100	9.5	I-0012
3	175	125/100	8	I-0847
4	152.4	76.2/76.2	9.53	I-0633
5	152.4	76.2/76.2	6.35	I-0725
6	152	80/80	10	I-0016
7	139.7	63.5	6.35	I-0722
8	126	90	6.5/7	I-0853
9	120	120/120	8	I-0329
10	120	70/70	8	I-0011
11	116.5	80/80	5	I-0567
12	110	15	5/7	I-0729
13	103	100/60	6.35	I-0009
14	102	51/51	6.4	I-0015
15	65	30/30	3	I-0017
16	58	30/30	3	I-0014
17	51	18/18	5	I-0005
18	43	86	6/4	I-0521
19	40	30/30	2	I-0013
20	40	30/30	3	I-0007
21	38	15/15	4	I-0001
22	25.4	15/15	4	I-0002
23	25	30/30	3	I-0006
24	80	60/60	3.3/4	I-0617

<p>deck</p> 	NO.	A	B	t1/t2	Item
	1	609.6	28.58	4.5/4.5	JB-0634
	2	540	28	4	JB-0830
	3	500	40	4/5	JB-0295
	4	500	40	4	JB-0775
	5	309	26	3.5/3.5	JB-0349
	6	304.8	54.15	6.3/6.3	JB-0296
	7	304.8	54.15	5/4.5	JB-0297
	8	750	3		PB-0308
<p>deck</p> 	NO.	A	B	t1/t2	Item
	1	500	40	2.8/4	JB-0492
	2	462	40	3/3	JB-0486
	3	450	40	2.8/4	JB-0485
	4	450	40	2.8/4	JB-0487
	5	450	40	2.8/4	JB-0488
	6	148	81	3/3	JB-0489
<p>deck</p> 		A	B	t/t2	Item
	1	301	160	8/5 (5.5)	JB-0294-A
	2	400	220	11/6.5	JB-0416
	3	301	160	6/4	JB-0294-B
<p>angle</p>	NO.	A	B	t	Item
	1	170	80	5	L-0330
	2	152.4	152.4	9.52	L-0803

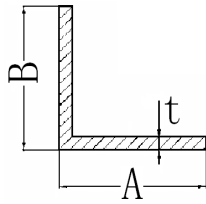

3	150	80	3	L-0641	
4	101.6	101.6	6.35	L-0637	
5	100	100	8	L-0035	
6	100	100	6	L-0562	
8	100	50	8	L-0019	
9	90	60	5	L-0028	
10	88.9	88.9	6.35	L-0653	
11	76.2	76.2	6.35	L-0022	
12	76	76	9.5	L-0023	
13	75	75	10	L-0030	
14	75	75	6	L-0027	
15	70	30	6.35	L-0038	
16	61.8	31.7	2.5	L-0343	
17	60.5	43.8	2.8	L-0461	
18	60	40	7	L-0701	
19	60	60	8	L-0034	
20	50.8	50.8	6.35	L-0026	
21	50	50	3	L-0033	
22	50	50	4	L-0037	
23	50	35	5	L-0032	
24	50	50	5	L-0029	
25	50	50	6	L-0464	
26	50	48	3	L-0805	
27	50	38	3	L-0773	
28	45	45	5	L-0021	
29	40	40	4.2	L-0025	
30	38.1	38.1	6.35	L-0652	
31	35	35	5	L-0020	
32	28	28	3	L-0036	
33	25	25	3	L-0031	

34	50	50	2.8	L-0438	
35	60	40	2.8	L-0421	
36	120	60	2.8	L-0427	
37	100	25	2.8	L-0408	
38	120	100	5	L-0514	
39	70.5	13.2	3.3	L-0610	
40	69.5	15	5	TL-0611	
41	30	36	3	L-0818	

box	NO.	A	t	Item
	1	180	15	F-0857
	2	101.6	9.52	F-0656
	3	101.6	6.35	F-0051
	4	101.6	6	F-0051-6
	5	100	10	F-0627
	6	90.6	4.3	F-0463
	7	90	6	F-0407
	8	88.9	6.35	F-0654
	9	88.5	12.5	F-0623
	10	88.5	6.15	F-0047
	11	88.5	3.1	F-0519
	12	82	6.35	F-0415
	13	82	6	F-0415-6.0
	14	80	3.5	F-0621
	15	80	12	F-0546
	16	76.2	9.52	F-0655
	17	76.2	6.35	F-0046
	18	76.2	4	F-0508
	19	75	6	F-0045
	20	68	5	F-0748
	21	64.5	3	F-0054
	22	63.2	5.9	F-0053
	23	62.6	5.7	F-0437
	24	60	4.5	F-0052
	25	60	2.5	F-0622
	26	60	4.25	F-0052-4.25
	27	60	4	F-0783
	28	58.2	3	F-0055
	29	50.8	6.35	F-0041-6.35

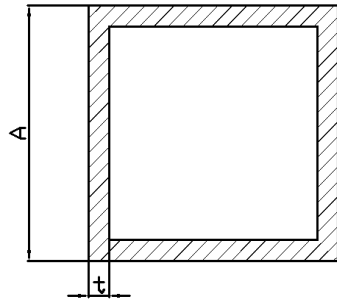

30	50.8	5	F-0516	
31	50.8	4	F-0041-4	
32	50.8	3.2	F-0041-3.2	
33	50	4	F-0682-4	
34	50	3.6	F-0682-3.6	
35	50	5	F-0682	
36	45.96	5.52	F-0826	
37	44	6	F-0040	
38	44	3	F-0520	
39	40	4	F-0771	
40	40	3	F-0785	
41	38.1	3.18	F-0632	
42	38	5	F-0049	
43	38	3.2	F-0048	
44	38	2	F-0509	
45	33.5	2	F-0786	
46	33.2	4	F-0268	
47	32	3	F-0791	
48	32	2	F-0791-2.0	
49	30	3	F-0056-3.0	
50	30	2	F-0056	
51	25	3	F-0039	
52	25	2	F-0737	
square tube				
	A	t/t2	Item	
1	393.7	3.18/8.26	F-0061	
2	342.9	3.18/7.62	F-0470	
3	292.1	3.18/6.35	F-0060	
4	241.3	3.18/6.35	F-0059	

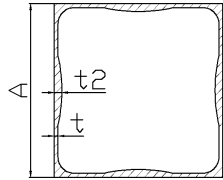

5	190.5	3.18/6.35	F-0058	
6	139.7	3.18/6.35	F-0057	
7	142.88	3.18/6.35	F-0382	
8	193.68	3.18/6.35	F-0383	
9	244.48	3.18/6.35	F-0384	
10	295.28	3.18/6.35	F-0385	

concave tube

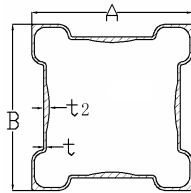

	A	B	t/t2	Item
1	190.5	190.5	3.175/6.5	F-0337

concave corner tube

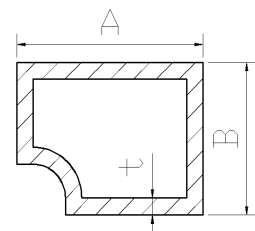

	A	B	t	Item
1	23	18	2	F-0338

strengthened tube

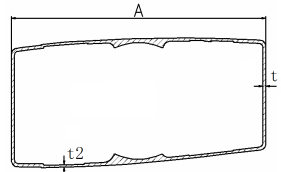

	A	t/t2	Item
1	330	4/3	F-0328
2	225	3/2.5	F-0348

rect tube	NO.	A	B	t1/t2	Item	
	1	800	300	3.5/10	J-0846	
	2	190.5	45.212	2.46	J-0711	
	3	160	60	3.5	J-0512	
	4	152.4	101.6	9.5/9.5	J-0071	
	5	140	60	7	J-0858	
	6	130	60	3.5	J-0513	
	7	120	90	10	J-0692	
	8	120	60	7/7	J-0483	
	9	101.6	50.8	3.125/6.35	J-0070	
	10	101.6	50.8	5/5	J-0070	
	11	101.6	50.8	8.05/8.55	J-0062	
	12	100	50	4	J-0799	
	13	95.5	45.5	4	J-0069	
	14	90	40	4/7	J-0068	
	15	75 (75.9)	35 (35.3)	5/5 (3.5/5.7)	J-0073	
	16	75	35	4.7/7.1	J-0532	
	17	65.5	30	4/5	J-0065	
	18	63.5	37	3.5/3.5	J-0066	
	19	60	36	2/2	J-0608	
	20	60	20	2	J-0753	
	21	50.8	40.64	2.28	J-0712	
	22	50.8	30	3/6.35	J-0072	
	23	50	30	3	J-0800	
	24	50	25	3/3	J-0368	
	25	48	31	4/4	J-0261	
	26	40	30	2.5	J-0784	
	27	38	15	3/3	J-0263	
	28	38	23.8	5/5	J-0074	
	29	37	20	2.5/2.5	J-0333	

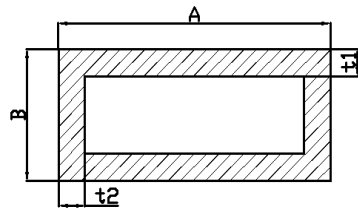

30	27.7	13.6	3/3	J-0064	
31	22	20	3/3	J-0511	
32	19	16	2	J-0856	
33	18.16	10.8	2. 200/2. 20 c	J-0063	
34	95	68	6/6	J-0412	
35	120	60	3	J-0451	
36	190	90	4	J-0450	
37	210	110	4	J-0449	
38	80	40	4	J-0618	
39	25	16	2	J-0763	
40	19	16	2	J-0808	
33	68	32	3. 2/3. 6	J-0264	

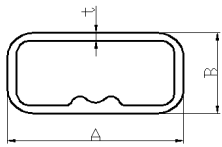

channel	NO.	A	B	t/t2	Item
	1	206	272	3	C-0794
	1	300	90	15/15	C-0079
	2	280	70	12/12	C-0094
	3	254	69.85	12.7/12.7	C-0651
	4	203.2	55.56	6.35/6.35	C-0650
	5	203.2	55.56	9.52/9.52	C-0639
	6	200	80	4/6	C-0602
	7	200	60	9.5/9.5	C-0105
	8	200	60	8	C-0419
	9	193	30	3/3	C-0108
	10	140	80	14	C-0777
	11	140	50	6/6	C-0372
	12	180	60	8/8	C-0093
	13	152.4	41.28	6.35/6.35	C-0631
	14	152.4	42.9	9.5/9.5	C-0102
	15	152.4	39.9	9.5/9.5	C-0101
	16	150	75	8/6	C-0466
	17	150	50	6/6	C-0090
	18	140	60	2.5	C-0842
	19	139.7	38.1	6.35	C-0721
	20	139.7	38.1	4.76/4.76	C-0638
	21	127	45	6.35/6.35	C-0100
	22	120	60	8/8	C-0078
	23	120	60	5/5.2	C-0467
	24	120	65	10/15	C-0545
	25	103	60	6.35/6.35	C-0091
	26	101.6	28.6	6.35/6.35	C-0099
	27	100	50	10	C-0696

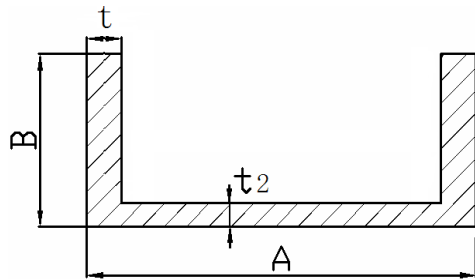

28	100	50	6/6	C-0089	
29	96.5	85	5/5	C-0568	
30	90	45	5.2/5.2	C-0394	
31	88.9	38.1	4.76/4.76	C-0630	
32	87	33	3.3/3.3	C-0082	
33	85	85	10	C-0678	
34	85	30	6/3.65	C-0334	
35	84.5	33.3	3.3	C-0083	
36	84	30	5/3.3	C-0080	
37	84	30	5/3.45	C-0085	
38	84	30	5/4.3	C-0086	
39	80	45	3.5/3	C-0787	
40	80.5	30	3	C-0768	
41	80	30	3.3/3.3	C-0314	
42	80	30	3.1/2.6	C-0389	
43	80	30	3/3	C-0396	
44	76.2	25	6.35/6.35	C-0077	
45	75	35	5/5	C-0454	
46	75	50/30	2.5	C-0666	
47	60	60	4.8/4.8	C-0104	
48	40	60	4	C-0861	
49	60	35	3	C-0772	
50	55	70	5/5	C-0084	
51	55	37	4/4	C-0281	
52	50	30	4/4	C-0107	
53	51	25	3	C-0767	
54	46	40*30	3/3	C-0490	
55	44.5	31.3	3.3	C-0081	
56	44	28	3.3/2.6	C-0313	
57	44	28	3.1/2.5	C-0390	

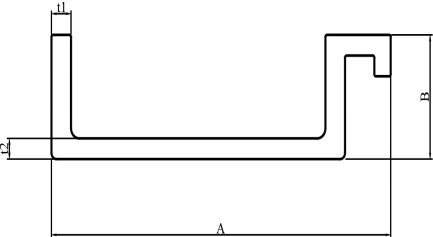
		58	42	42	3	C-0166		
		59	42	24	5	C-0167		
		60	41.5	41.5	3.5/3.5	C-0103		
		61	44	30.2	3/3	CX-0544		
		62	40	15	4/4	C-0092		
		63	40	15	3/3	C-0538		
		64	38.1	38.1	6.35	C-0728		
		65	38	25	2/2	C-0477		
		66	37	20	2.5	C-0332		
		67	35	15	2	C-0838		
		68	25	30	3/3	C-0095		
	channel	NO.	A	B	t/t2	Item		
		1	208	60	12/10	C-0778		

cable tray		NO.	A	B	t/t2	Item
		1	600	80	4.5/5	C-0592
		2	600	50	4.5/5	C-0431
		3	400	80	4/5	C-0420
		4	400	50	4/5	C-0432
		5	300	50	5/4	C-0155
		6	300	50	5/3	C-0169
		8	200	50	5/3	C-0154
		9	200	50	4/3	C-0165
		10	200	80	5/3	C-0164
		11	200	50	3/3	C-0352
		12	150	50	5/3	C-0153
		13	150	50	4/3	C-0157
		14	150	80	4/3	C-0158
		15	100	50	5/3	C-0152
		16	100	50	4/3	C-0156
		17	100	80	4/3	C-0160
		18	100	50	3/3	C-0350
		19	50	50	3/3	C-0163
		20	50	80	4/3	C-0162
		21	50	50	3/3	C-0161
		22	80	80	3.2/3.2	C-0159
		23	200	100	4.5/3.5	C-0148
		24	100	50	3/3	C-0147
		25	100	40	4/3	C-0812
		26	150	40	4/3	C-0813
		27	200	40	4/3	C-0814

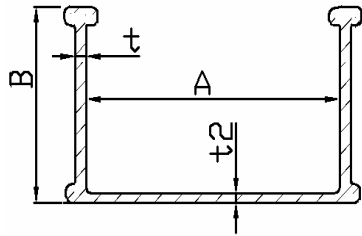

28	300	40	5/3	C-0815	

tray cover	NO.	A	A2	t	Item
	2	236		3	C-0172
	3	220		3	C-0353
	4	184		3	C-0341
	5	120		3	C-0351
	6	96		3.2	C-0170
	7	84		3	C-0173
	8	134		3	C-0174
	9		100	4	C-0175
	10		200	4.5	C-0176
	11		300	5	C-0177

round tube	NO.	A	t	Item	
	1	244.475	3.24	G-0715	
	2	193.675	3.24	G-0713	
	3	168	6	G-0506	
	4	155	6	G-0505	
	5	152	4	G-0529	
	6	130	6	G-0504	
	7	123	6	G-0503	
	8	117	6	G-0502	
		106	3.5	G-0126	
	9	104	6	G-0501	
	10	98	6	G-0500	
	11	92	8	G-0517	
	12	92	6	G-0499	
	13	85	6	G-0498	
	14	82	3	G-0587	
	15	79	6	G-0497	
	16	76	6	G-0124	
	17	76	4	G-0125	
	18	73	5	G-0123	
	19	71	3.5	G-0122	
	20	60.33	4.7	G-0462	
	21	60	3.5	G-0121	
	22	60	2.63	G-0146	
	23	51.6	2.55	TX-0199	
	24	50	5	G-0585	
	25	50	2.6	G-0750	
	26	50	2.6	G-0751	
	27	50	3.5	G-0752	
	28	50	2.8	G-0413	

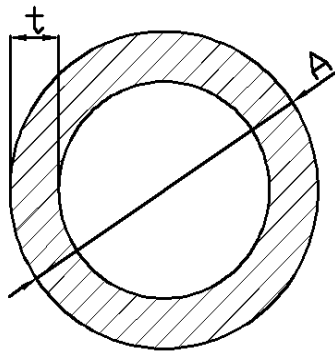

29	50	2	G-0586	
31	48.5	6.75	G-0410	
32	48.5	2.5	G-0439	
33	44	2.65	G-0588	
34	40	4		
35	40	2	G-0584	
36	39.7	2.45	G-0831	
	39.7	3.2	G-0340	
37	38.35	4.83	G-0680	
38	38	5	G-0120	
39	38.1	4.7	G-0522	
40	38	2.45	G-0620	
41	38	3	G-0132	
42	36	5		
43	36	2.2	G-0460	
44	36	3	G-0311	
45	32.14	3.5	G-0764	
46	31.5	3.18	G-0315	
47	31.5	2.54	G-0315-2.5	
48	31.5	2.25	G-0469	
49	32/34.5	3.25	G-0138	
50	32	4.8	G-0119	
51	32	3	G-0130	
52	32	2	G-0117	
53	32	2.5	G-0118	
54	30.3	2.5	G-0375	
55	30	4.8	G-0131	
56	30	2	G-0116	
57	30	2.5	G-0342	
58	28	3	G-0115	

59	28	4	G-0128	
60	28	2.75	G-0423	
61	28	1.5	G-0422	
62	27.4	3	G-0136	
63	26.97	2	G-0379	
64	26	2.5	C-0465	
65	25.4	3	G-0137	
66	25.4	2.5	G-0114	
67	25	3	G-0354	
68	25	2.5	G-0354-2.5	
69	25	2	G-0139-2	
70	24	2	G-0135	
71	24	3	G-0113	
72	23.8	1.99	G-0135-2	
73	23.5	3	G-0135-3	
74	23	3	G-0112	
75	23	2.5	G-0129	
76	22	2.5	G-0134	
77	22	3	G-0425	
78	22	1.5	G-0424	
79	21.5	2	G-0145	
80	20	2	G-0111	
81	19	3	G-0110	
82	18.8	3.2	G-0133	
83	12.7	1.75	G-0226	
84				
elliptical tube	A	B	t	Item
1	28.6	25.4	2.67	TG-0472

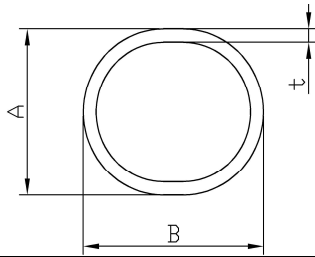

doual tube

2	23.01	19.84	5.06	G-0507	

	A	B	t	Item	
1	66.5	28.5	3.1	G-0434	

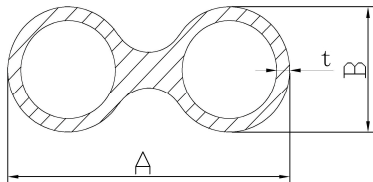

triangular tube

	A	B	t	Item	
1	29.7	20.32	3.94	G-0373	

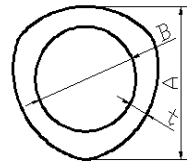

tent poles	NO.	A	B	Item
	1	12.7	4.0	XW-0231-4.0
	2	12.7	4.5	XW-0231-4.5
	3	12.7	5.0	XW-0231-5.0
	4	12.7	9.0	XW-0231-9.0
	5	9.5	3.0	B-0219-3.0
	6	8.5	3.2	XW-0235-3.2
	7	8.5	3.5	XW-0235-3.5
	8	8.5	3.8	XW-0235-3.8
	9	8.5	5.0	XW-0235-5.0
	10	7.9	3.2	XW-0232
	11	7.9	3.5	XW-0233
	12	7.9	4	XW-0234
	13	7	3.2	B-0216-3.2
	14	7	3.5	B-0216-3.5
	15	6	3.0	XW-0230-3.0
	16	6	3.2	XW-0230-3.2
	17	14	9.0	B-0227-9.0
	18	11	4.0	B-0221-4.0
	19			
	20			
	21			

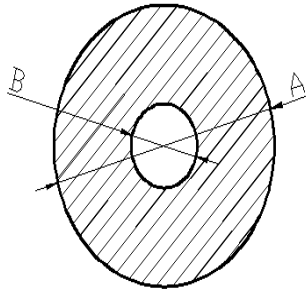

rod	NO.	A	Item
	1	38	B-0224
	2	32	B-0223
	3	28	B-0115
	4	25.4	B-0211
	5	25	B-0374
	6	24	B-0210
	7	23.7	B-0209
	8	22	B-0208
	9	20	B-0207
	10	18	B-0206
	11	16	B-0228
	12	16/8	B-0675
	13	16/12	B-0675
	14	14	B-0227
	15	12.7	B-0222
	16	12.5	B-0226
	17	12	B-0225
	18	11	B-0221
	19	9.5	B-0219
	20	9	B-0797
	21	8.5	B-0218
	22	7.9	B-0217
	23	7	B-0216
	24	6.32	B-0215
	25	6	B-0214
	26	5	B-0213
	27	4	B-0212

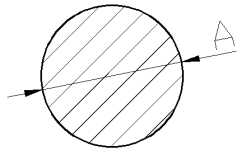

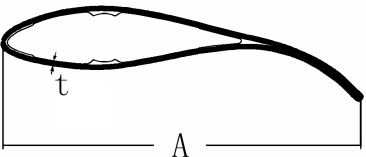
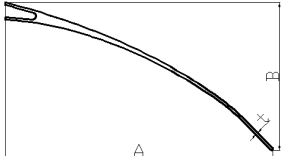
blade	NO.	A		t	Item	
	1	900		3.2	YP-0452	
	2	610		3.5	YP-0458	
	3	610		4	YP-0256	
		590		3	YP-0720	
		540		4.5	YP-0694	
	4	533		3	YP-0493	
	5	371		3	YP-0443	
6	355		2.5	YP-0258		
7	270		3.0	YP-0740		
		A	B	t	Item	
	1	533	284.9	5	YP-0339	
flat	NO.	A		t	Item	
	1	200		9.5	BT-0642	
	2	136		6.35	BT-0236	
	3	110		4	BT-0859	
	4	101.6		12.7	BT-0635	
	5	101.6		6.35	BT-0636	
	6	100		2.8	BT-0583	
	7	87.9		5	BT-0245	
	8	80		8	BT-0244	
	9	76.2		12.7	BT-0629	
	10	76.2		6.35	BT-0806	
	11	76		22	BT-0241	
	12	60		3	BT-0246	
	13	50		4	BT-0247	

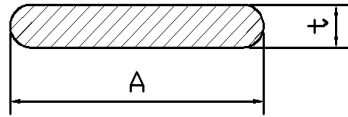

14	40	8	BT-0832	
15	40	5	BT-0242	
16	40	3	BT-0475	
17	40	4	BT-0249	
18	39	13	BT-0801	
19	38.5	13	BT-0358	
20	32	6	BT-0471	
21	32	3	BT-0251	
22	30	4	BT-0474	
23	30	3	BT-0798	
24	28.58	3	BT-0312	
25	23	2	BT-0359	
26	20	4	BT-0254	
27	20	6	BT-0253	
28	16	6	BT-0553	
29	16	2	BT-0250	
30	15	4.5	BT-0473	
31	15	2.5	BT-0252	
32	15	4	BT-0238	
33	9	2.5	BT-0248	
34	53	2.5	BT-0523	
35	50	3.2	BT-0738	

panel

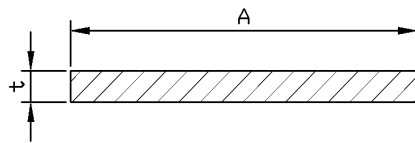

	A	B	Item	
1	598	3	PB-0793	
2	582	4	PB-0309	
3	500	6	PB-0578	
4	270	8	PB-0779	
NO.	A	B	t/t2	Item

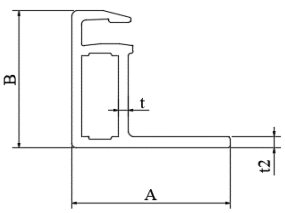
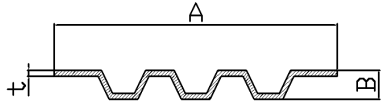
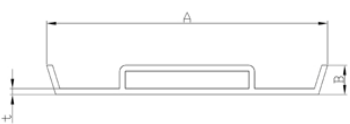
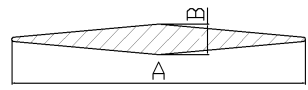
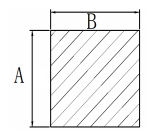
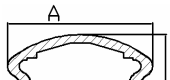

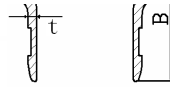
	1	33	30	2/2.5	BK-0840	
	2	33	30	2/2.5	BK-0845	
kick plate						
	1	150	15	3	TJ-0306	
	2	110	18.5	3.5	TJ-0300	
	3	150	15	5	TJ-0496	
kick plate						
	1	150	15	3	TJ-0305	
	diamond flat					
	1	24	4		LX-0269	
	square rod					
	1	25	10		JB-0362	
	2	10	11		FB-0361	
	3	6.4	6.4		FB-0270	
	4	10	10		FB-0484	
handrail						
	1	75	60	4.5	FS-0271	
	handrail					

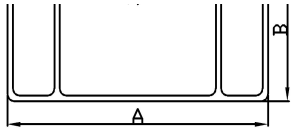
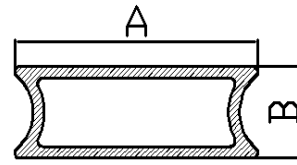
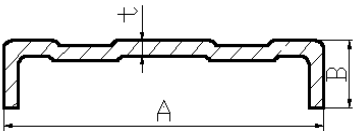
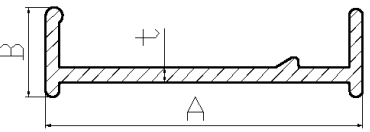
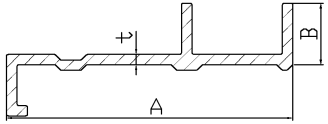

hollow plank					
	NO.	A	B	t	Item
	1	634	60	3.2/3.5	KF-0665
	2	600	80	4/3.5	KF-0590
	3	600	60	3.2/3.5	KF-0664
	4	317	60	3.2/3.5	KF-0704
	5	300	60	2.8/3.5	KF-0705
	6	617	60	3.2/3.5	KF-0706
	7	600	60	2.8/3.5	KF-0707
	8	140	20	2.5	KF-0790
hollow plank					
		A	B	t	Item
	1	270	200	5	KX-0447
	2	200	120	5	KX-0446
hollow plank					
		A	B	t	Item
	1	1000	90	4	KX-0510
	2	491	49.1	5/3.8	KF-0645
	3	241	49.1	5/3.8	KF-0669
	4	227.25	210	3.2	KF-0757
	5	150	149.28	3.2	KF-0758
	6	200	100	4	KX-0445
	7	190	38	3	KX-0481
	8	180	80	4	KX-0448

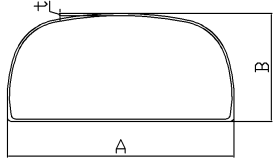
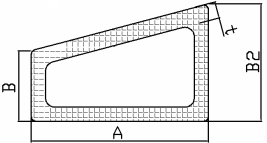
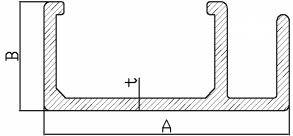
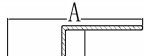
	9	170.5	49.1	3.8	KF-0644	
	10	170.5	49.1	3.8	KF-0668	
	11	116	49.1	3.8	KF-0667	
	12	116	49.1	3.8/5	KF-0670	
center leg		A	B		Item	
	1	66	23.5		ZT-0325	
cable ladder rail	NO.	A	B	t	编号	
	1	200	25	5.5	Q-0185	
	2	100	25	4.5	Q-0182	
	4	150	42	4	Q-0187	
	5	150	42	7	Q-0186	
	6	100	37	4	Q-0183	
	7	75	32	6	Q-0179	
	8	70	18	4	Q-0331	
	9	150	30	5	Q-0181	
	10	135	30	5	Q-0180	

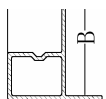
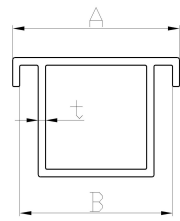
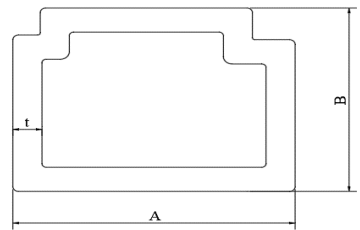
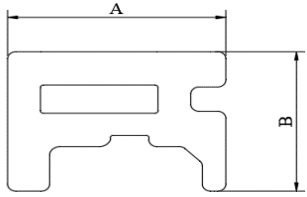
OTHERS					
radomes					
	NO.	A	B	t	Item
	1	289	85	2.5	TX-0201
	2	340	230	2.8	TX-0194
	3	264	99.71	2.8	TX-0195
	4	262	118	2.8	TX-0189
	5	262	120	2.5	TX-0196
	8	157	95.5	2.5	TX-0197
	9	152	49.3	2.8	TX-0190
	10	280		2.8	TX-0198
	trapezoid tube				
	NO.	A	B/B2	t	Item
	1	140	41.2/61	3.5	TX-0657
	2	76	158/9.9	3.5	TX-0658
E-shape					
	NO.	A	B	t	Item
	1	144	30	5	S-0356
door frame					
	NO.	A	B		Item
	1	100	80		MK-0290
	2	100	100		MK-0418

					
	3	A	B	t	Item
		72	66	3.2	MK-0435
door frame	NO.	A	B	t	Item
	1	49.6	38.7	5.11	MK-0769
	NO.	A	B	t	Item
	1	33.02	25.07		MK-0770
	NO.	A	B	t	Item
	1	39.1	44.9		YX-0774

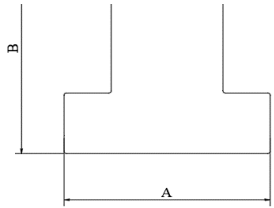

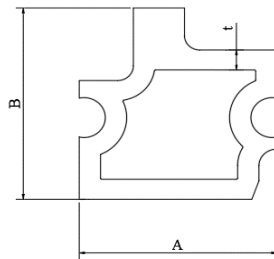

NO.	A	B	t	Item	
1	37	38.18	4	MK-0795	

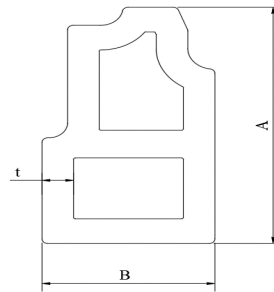

NO.	A	B	t	Item	
1	38.29	21.87	4	MK-0796	

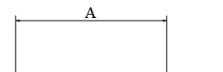

NO.	A	B	t	Item	
1	40.7	48.11		MK-0802	

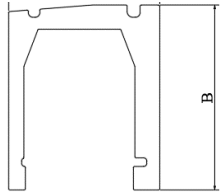

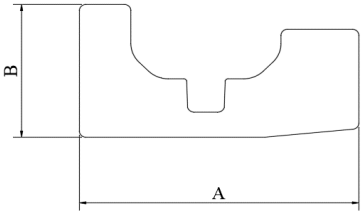

NO.	A	B	t	Item	
1	42.4	21.42		MK-0807	

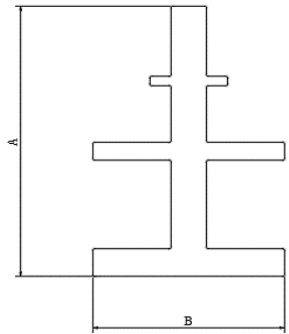

NO.	A	B	t	Item	
1	64.2	43		MK-0809	

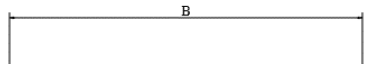

NO.	A	B	t	Item	
1	26.63	79.69		MK-0810	

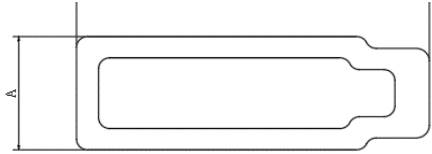

edge strip	NO.	A	B	t	Item
	1	10	25		MK-0756
frame strip	NO.	A	B	t	Item
		25	45	3.5	MK-0755
panel box	NO.	A	B	t	Item

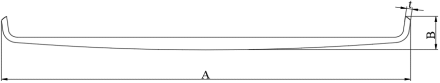
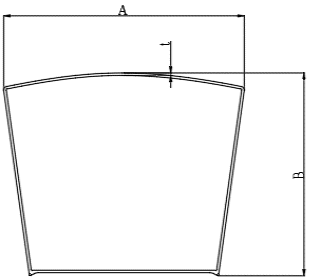
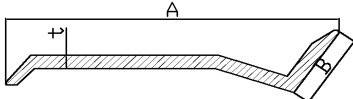
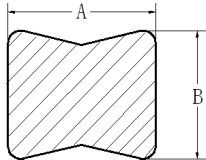
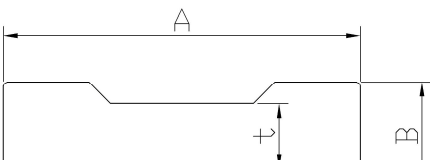
		288.6	25	4	MB-0788	
		368.7	323	4	XT-0789	
<p align="center">"7" section profile</p>	<p align="center">32</p>	<p align="center">A</p>	<p align="center">B</p>	<p align="center">t</p>	<p align="center">Item</p>	
	<p align="center">1</p>	<p align="center">139.15</p>	<p align="center">29</p>	<p align="center">5</p>	<p align="center">GZ-0284</p>	
<p align="center">connector</p>	<p align="center">NO.</p>	<p align="center">A</p>	<p align="center">B</p>	<p align="center">t</p>	<p align="center">Item</p>	
	<p align="center">1</p>	<p align="center">23</p>	<p align="center">19.5</p>		<p align="center">LJ-0397</p>	
	<p align="center">2</p>	<p align="center">50</p>	<p align="center">15</p>	<p align="center">9</p>	<p align="center">I-0386</p>	

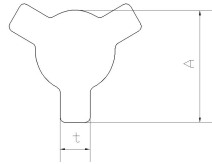
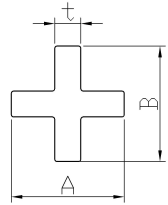

double angle

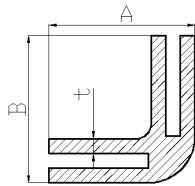

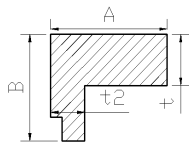

L bar

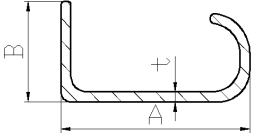
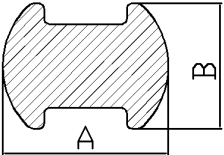
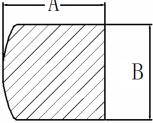

C channel

NO.	A	B	t	Item
1	26	26	6	LJ-0426
2	16	16	4	LJ-0478
3	14	14	3.5	LJ-0693
4	11		3	LJ-0491
NO.	A	B	t	Item
1	25	25	3	L-0286
NO.	A	B	t	Item
1	15.92	13.94	6.5/4.5	L-0327
NO.	A	B	t	Item

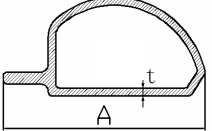
	1	82	31	3.17	CX-0293
	2	60	31	3.17	CX-0292
cross rod 1					
	1	14	10.54		MH-0298
	2	9.11			MH-0387
cross rod 2					
	1	7.5	7		MH-0299
	2	7	5		MH-0388
connector					
	1	39	10		PC-0302
top tray beam					
	1	171.4	5		ST-0335
bottom tray beam					
		A	t		Item

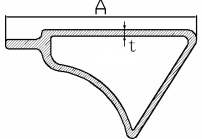
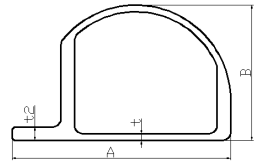
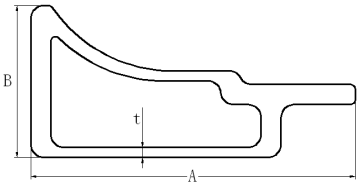
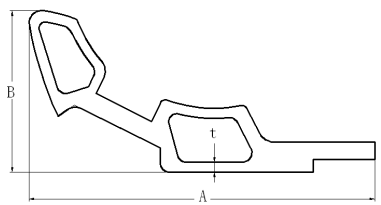

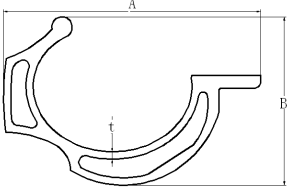
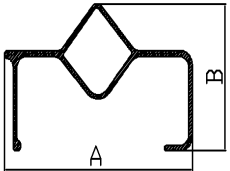
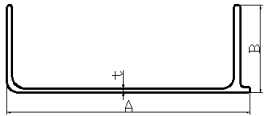
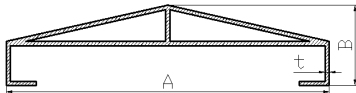
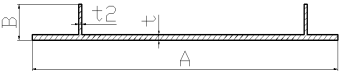
	1	209.6	6	XT-0336	
	1	A 157.23	B 97.03	t/t2 4.83/9.65	Item SC-0364
		A 157.23	B 97.03	t 4.83	Item XC-0365
		A 177.77	B 81.51	t 5.08	Item YSC-0366
		A	B	t	Item

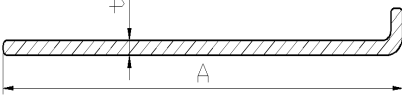
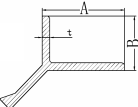
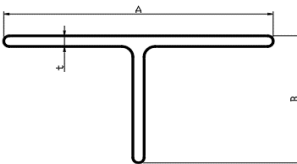
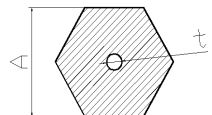
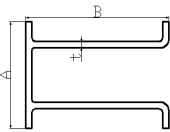
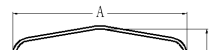
		180.8	114.7	5.08	YSC-0367	
"Σ" profile		A	B		Item	
	1	190.2	77		XG-0282	
	2	190.2	114.81		XG-0316	
	3	190.2+114.81	114.81		XG-0317	
		A	B	t	Item	
	1	188.9	63.5	3.05	C-0357	
		A	B	t	Item	
		268	65	3.5	ST-0360	
		A	B	t/t2	Item	
	1	246	27	4/2.5	DB-0363	
		A		t	Item	

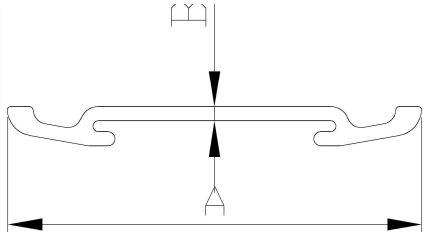
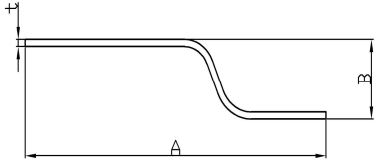
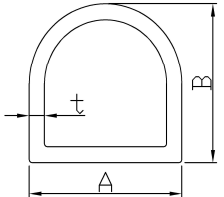
	1	100		3	CB-0301	
Y shape		A	B	t	Item	
	1	55	35	5	Y-0283	
T shape		A	B	t	Item	
	1	152.4	76.2	6.35	T-0640	
	2	50	38	2/4	T-0849	
	3	40	11	2	T-0855	
hexagonal profile		A		t	Item	
	1	22		6.5	L-0345	
		A	B	t	Item	
	1	100	140	5	P-0395-2	
cover		A	B	t	Item	
	1	169.2	137.2	2.8	Z-0369	
	2	162	130	2.8	Z-0370	

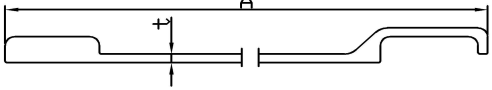
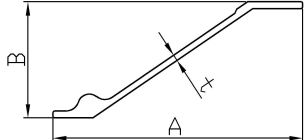
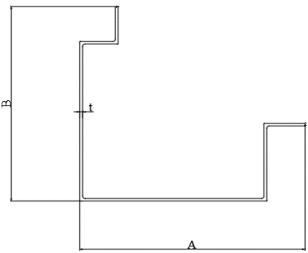
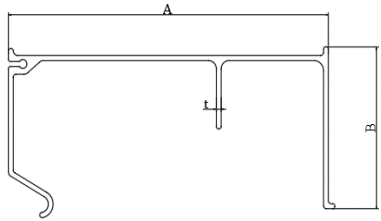
	3	111	30	2.1	G-0480	
	1	A 101.6	B 3.3	Item BT-0430		
Z shape		A	B	t	Item	
	1	200	45	4	Z-0440	
	1	A 50	B 50	t 5	Item D-0459	
cover		A		t	Item	

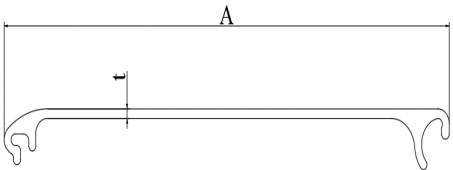
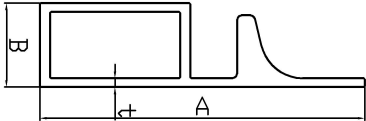
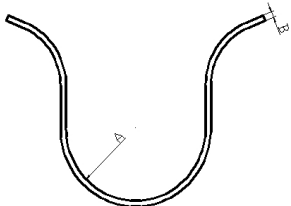
	1	783		3	B-0468
blind blade		A	B	t	Item
	1	75	34	1.8	YP-0476
	2	70	28	2	YP-0765
		A	B	t	Item
	1	241	228	3	ZXB-0823
	2	241	181	3	ZXB-0828
	3	240	140	3	ZXB-0836
	4	320	180	3	ZXB-0837
	5	210	200	3	ZXB-0841
		A	B	t	Item
		200	95	3	GNB-0825

		A	B	t	Item	
		190.92		3	GNB-0829	
						
F shape						
		A	B	t	Item	
		190	48	5	F-0482	
		A		B	Item	
	1	38	3	KY-0515		
	2	10	3	KKY-0573		
	3	25	3	KKY-0574		
	4	45	3	KKY-0575		
		A		B	Item	
	1	111	40	ZJ-0534		

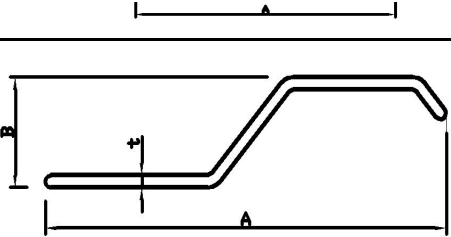
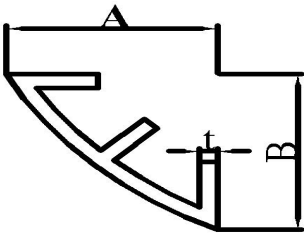
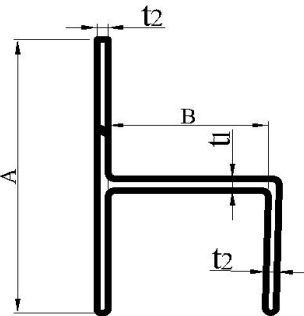
	4	90	22.5	2.5	WDYC-0558	
	1	A 69	B 69	t 6	Item QB-0619	
<p>H shape</p> 	NO.	A	B	t1/t2	Item	
	1	223	51	4/3.5	HX-0646	
	NO.	A	B	t1/t2	Item	

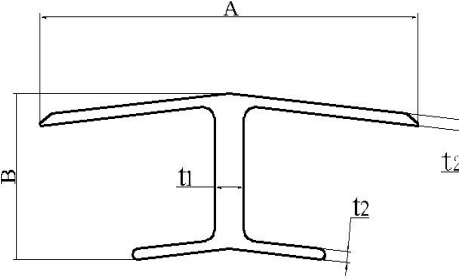
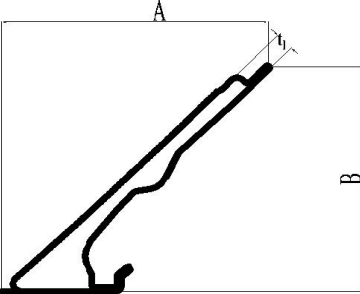
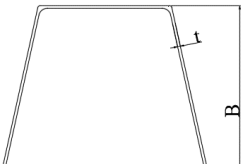
	1	156	65	12/4	I-0643	
	NO.	A	B	t1/t2	Item	
	1	151	134	11/2.5	GRXC-0659	
	NO.	A	B	t	Item	
	1	250	250	3.1	C-0759	

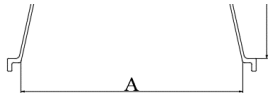

NO.	A	B	t1/t2	Item
-----	---	---	-------	------

	84	60	4	YX-0695
--	----	----	---	---------

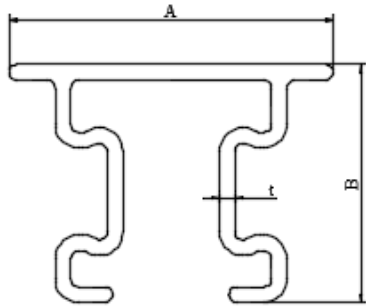

NO.	A	B	t1/t2	Item
-----	---	---	-------	------

	88	30	3.9	YX-0716
--	----	----	-----	---------

	170	77	6	YX-0741
--	-----	----	---	---------

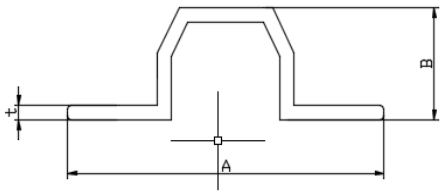

NO.	A	B	t1/t2	Item
-----	---	---	-------	------

	155	57	3.5	YX-0717
--	-----	----	-----	---------

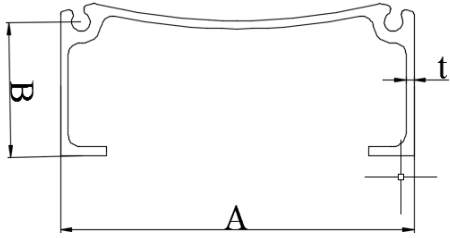

NO.	A	B	t1/t2	Item
	331	403	5	YX-0723
1	43.3	18		YX-0754
2	34	18		YX-0848

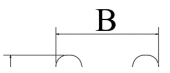
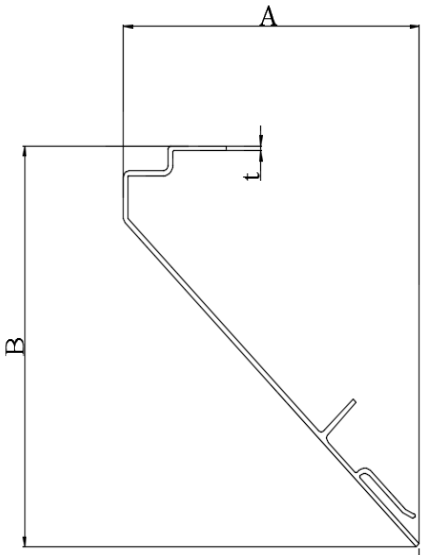

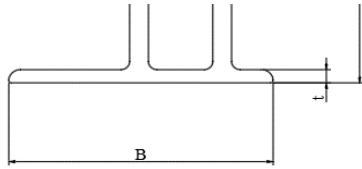

NO.	A	B	t	Item
	64	58	2.8	YX-0781

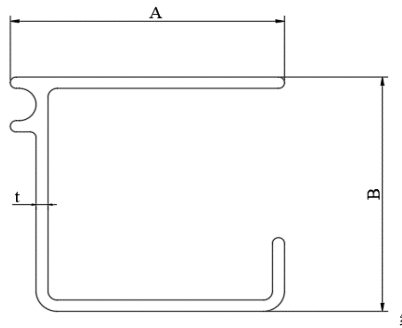

NO.	A	B	t	Item
	143	107	3	YX-0782

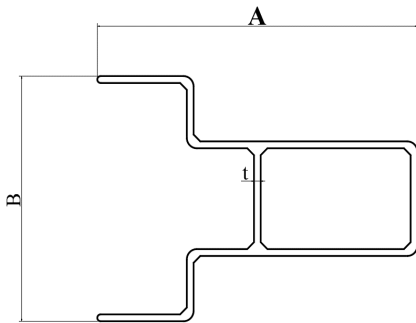

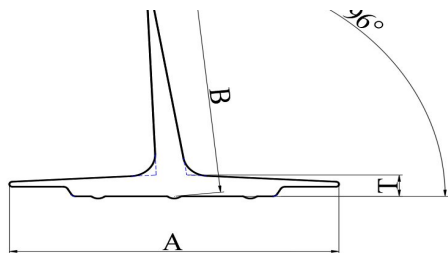

NO.	A	B	T	Item
1	40	20		YX-0816

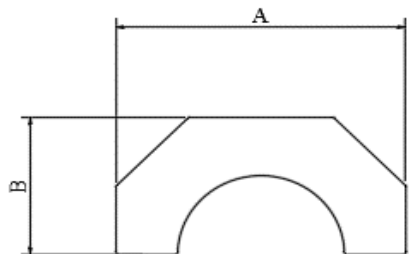

NO.	A	B	T	Item
1	40	20		YX-0816